

THE INFORMATION CONTAINED IN THIS DOCUMENT IS PROPRIETARY TO JEN JIA PRECISION TECHNOLOGY CO.LTD, ANY REPRODUCTION IN PART OR WHOLE WITHOUT PRIOR WRITTEN APPROVAL OR AUTHORIZATION OF JEN JIA PRECISION TECHNOLOGY CO.LTD IS STRICTLY PROHIBITED.

RoHS COMPLIANT

REVISIONS

| REV | ECN NO. | DESCRIPTION | APPROVED BY | DATE |
|-----|---------|------------------|-------------|------------|
| 1 | | PROPOSAL DRAWING | Helly Luo | 2017-11-13 |
| 2 | △ | UPDATED | Helly Luo | 2017-12-27 |
| 3 | △ | Change Packed | Helly Luo | 2018-01-30 |

Notes:

- 1.Material&Finish:
 1.1Housing:High Temperature Thermoplastic UL94V-0 Color Black.
 1.2Terminal:Copper Alloy,T=0.20; Contact Area:See P/N
 Solder Area:Gold Flash or Matte Tin 120U"
 Over all Nickel 50U".

2.Speciality:

- 2.1 Rated Current:1.0A
 2.2 Rated Voltage:12V
 2.3 Contact Resistance:50mΩ MAX(Initial)
 2.4 Insulation Resistance:100MΩ MIN
 2.5 Dielectric Withstanding Voltage: 500V AC.
 2.6 Durability:2000 Cycles Min.
 2.7 Mating Force:0.8-3.0kgf(Initial)
 2.5kgf max(after Durability test)
 Unmating Force:0.6-1.8kf(Initial)
 0.5kgf min(after Durability test)

81JK23M06X O R

TERMINAL PLATING: 2:GOLD FLASH
 3:30u"plated

PACKING: R: TAPE& REEL

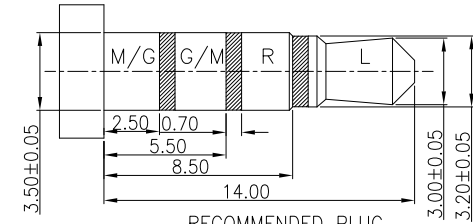
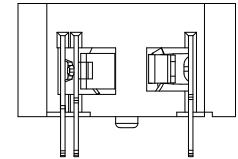
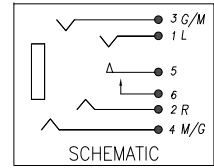
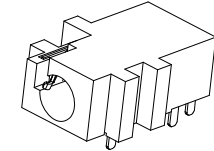

RECOMMENDED PLUG
 Ø3.5 4 POLE STANDARD PLUG

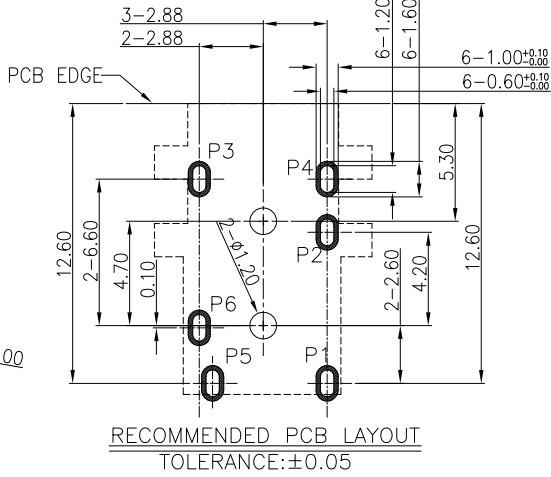
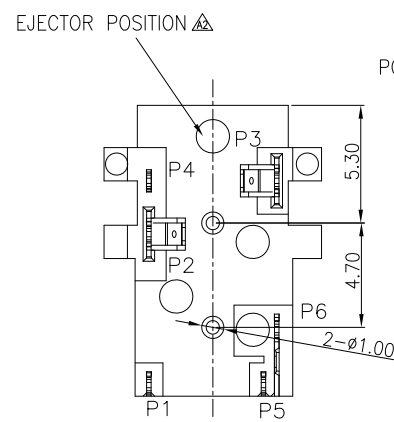
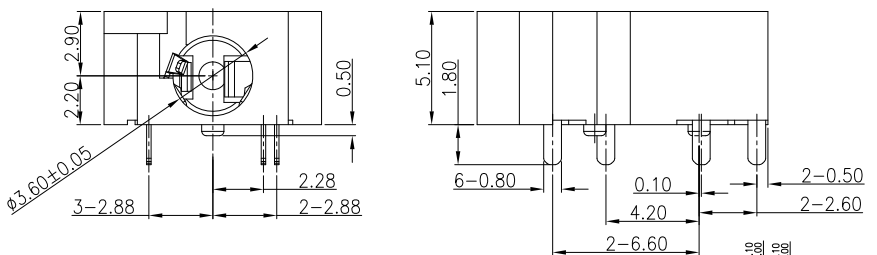
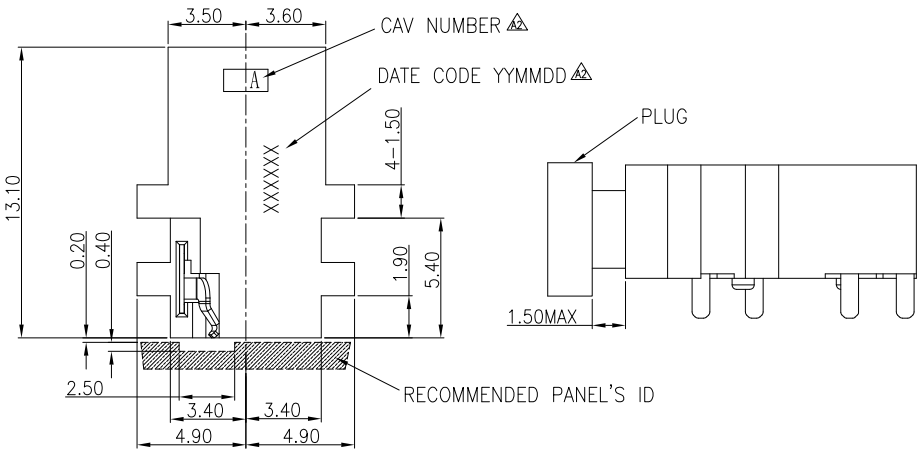

DIMENSIONS:
 □ MM [INCH] □ INCH [MM] ☒ MM ONLY

UNLESS OTHERWISE SPECIFIED,
 GENERAL TOLERANCE:
 DECIMALS ANGLES
 X. ±0.30 X' ±5°
 .X ±0.20 X' ±3°

CAD GENERATED DRAWING,
 DO NOT MANUALLY UPDATE

THIRD ANGLE PROJECTION

JJP Jen Jia Precision Technology Co., Ltd.

| TITLE | | 3.5Ømm AUDIO JACK DIP TYPE | |
|-----------------------|--------------|----------------------------|------------|
| PART NO. | 81JK23M06XOR | APPROVED BY | JASON MENG |
| DRAWING NO. | 81JK23M06XOR | CHECKED BY | STEVEN LIU |
| MATERIAL | | DRAWN BY | Helly Luo |
| FINISH | | GENERATD DATE | 2018-01-30 |
| SCALE | FREE | SHEET | 1/2 |
| REV. | 3 | SIZE: | A4 |
| FILE NO.:JJP-A-05-003 | | | |

DO NOT SCALE DRAWING

THE INFORMATION CONTAINED IN THIS DOCUMENT IS PROPRIETARY TO JEN JIA PRECISION TECHNOLOGY CO.,LTD. ANY REPRODUCTION IN PART OR WHOLE WITHOUT PRIOR WRITTEN APPROVAL OR AUTHORIZATION OF JEN JIA PRECISION TECHNOLOGY CO.,LTD IS STRICTLY PROHIBITED.

RoHS COMPLIANT

REVISIONS

| REV | ECN NO. | DESCRIPTION | APPROVED BY | DATE |
|-----|---------|------------------|-------------|------------|
| 1 | | PROPOSAL DRAWING | Helly Luo | 2017-11-13 |
| 2 | △ | UPDATED | Helly Luo | 2017-12-27 |
| 3 | △ | Change Packed | Helly Luo | 2018-01-30 |

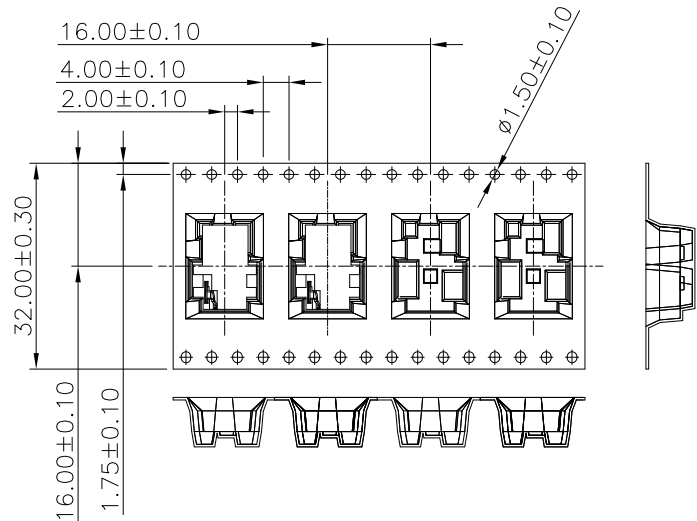
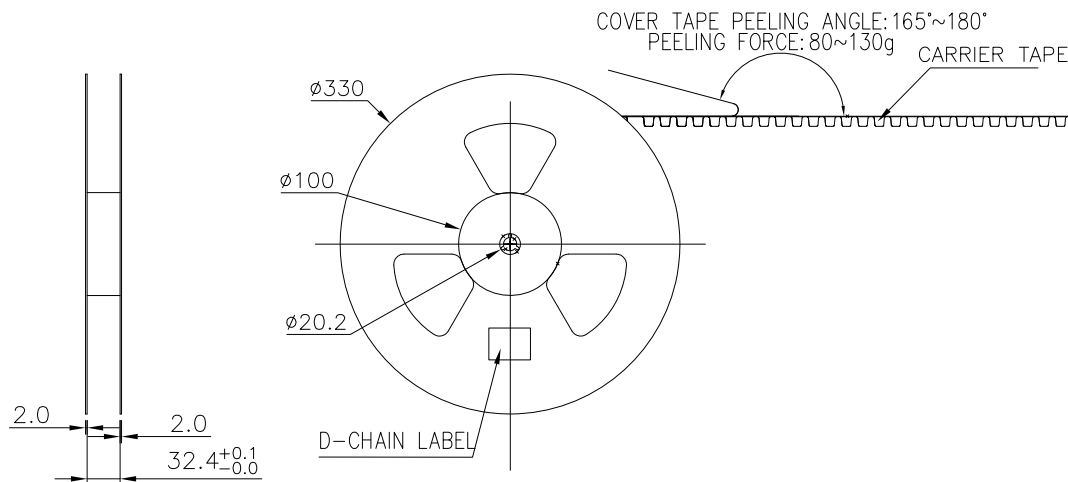
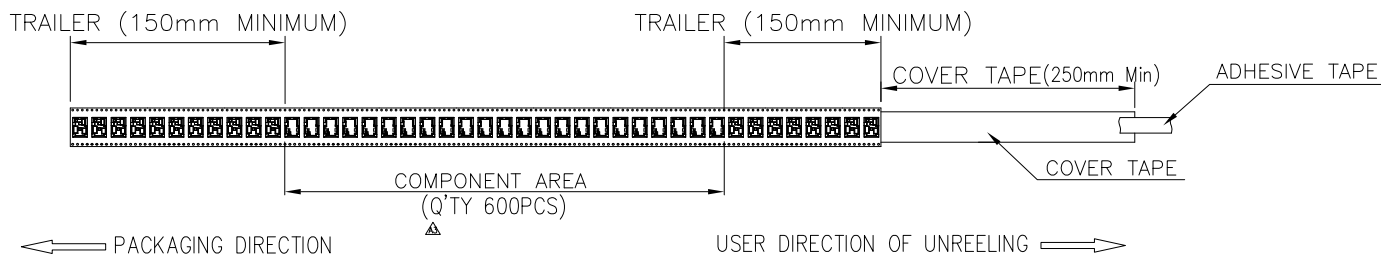

| | | | | | |
|------|--------------|-----------|-------------|-------------|-------------|
| 1 | 81JK23M06X0R | 600 | 9 | 5400 | 340X340X350 |
| ITEM | PRODUCT No. | Q'TY/REEL | REEL/CARTON | Q'TY/CARTON | CARTON SIZE |

DIMENSIONS:
 MM [INCH] INCH [MM] MM ONLY

UNLESS OTHERWISE SPECIFIED, GENERAL TOLERANCE:

DECIMALS ANGLES
 X. ±0.30 X' ±5°
 .X ±0.20 .X' ±3°

CAD GENERATED DRAWING, DO NOT MANUALLY UPDATE

THIRD ANGLE PROJECTION



JJP Jen Jia Precision Technology Co., Ltd.

| | | | |
|-------------|----------------------------|---------------|-----------------------|
| TITLE | 3.5ømm AUDIO JACK DIP TYPE | | |
| PART NO. | 81JK23M06X0R | APPROVED BY | JASON MENG |
| DRAWING NO. | 81JK23M06X0R | CHECKED BY | STEVEN LIU |
| MATERIAL | | DRAWN BY | Helly Luo |
| FINISH | | GENERATD DATE | 2018-01-30 |
| SCALE | SHEET | REV. | SIZE: A4 |
| FREE | 2/2 | 3 | FILE NO.:JJP-A-05-003 |

DO NOT SCALE DRAWING