

ROHS
COMPLIANT

REV	DESCRIPTION	ECN NO.	DATE	DRAW	APPROV.
A	Proposal drawing		2008-06-05	Annie	Jason

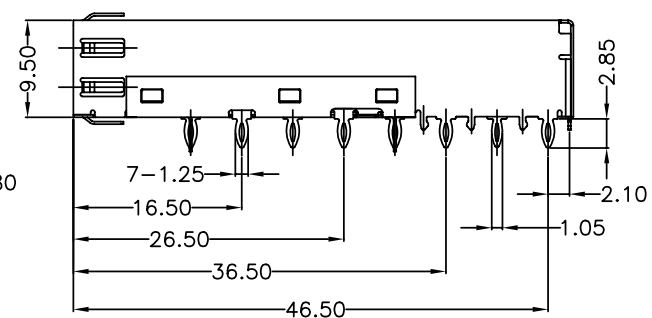
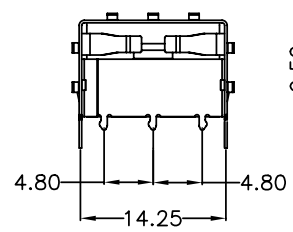
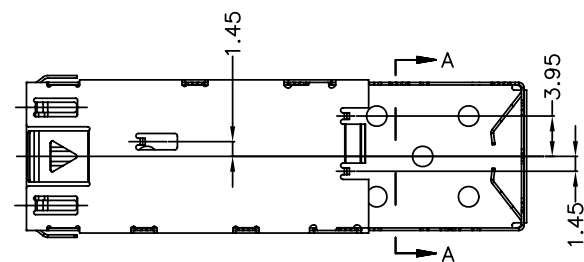
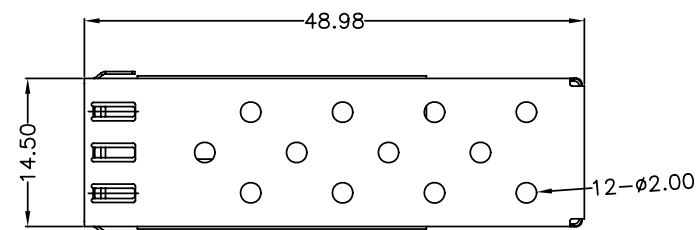
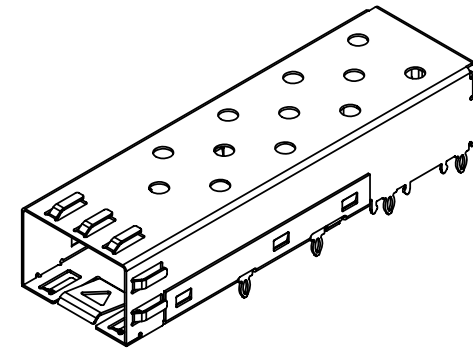
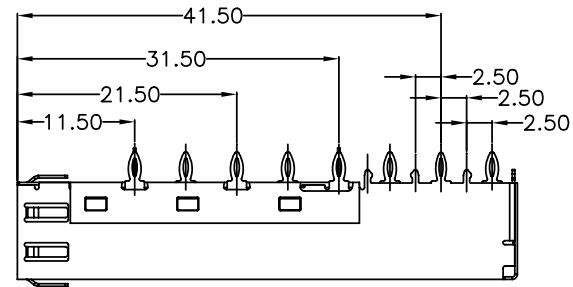

MATERIALS

SHELL: COPPER ALLOY, NICKEL PLATED

PART NUMBER

J198015 - 0 N - 1 6 L

SERIES — NICKEL PLATED ON METAL SHIELD — LEAD FREE — TRAY PACKAGE

JJP Jen Jia Precision Technology Co., Ltd.

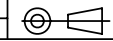
TITLE	SFP CAGE, R/A, METAL SHIELD, PRESS FIT TYPE, WITH SPRING			
PART NO.	J198015-0N-16L	APPRD	Mark	
DRAW NO.	J198015-0N-16L	CHKD	Steve	
THIRD ANGLE PROJECTION		DRAW	Annie	
		DATE	2008-06-05	
SCALE	SHEET	REV	UNIN	
NONE	1/1	A	MM	

LINEAR:	ANGLES:
.X±0.30 .	±3°
XX±0.20 .	
XXX±0.10	