

THE INFORMATION CONTAINED IN THIS DOCUMENT IS PROPRIETARY TO JEN JIA PRECISION TECHNOLOGY CO.LTD. ANY REPRODUCTION IN PART OR WHOLE WITHOUT PRIOR WRITTEN APPROVAL OR AUTHORIZATION OF JEN JIA PRECISION TECHNOLOGY CO.LTD IS STRICTLY PROHIBITED.

RoHS COMPLIANT

REVISIONS

REV	ECN NO.	DESCRIPTION	APPROVED BY	DATE
1		PROPOSAL DRAWING	JASON MENG	2008-03-08

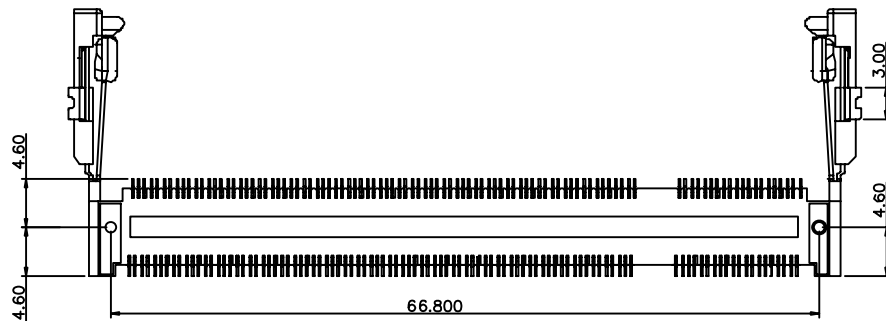
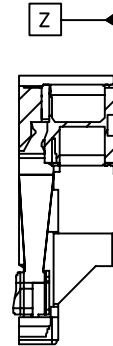
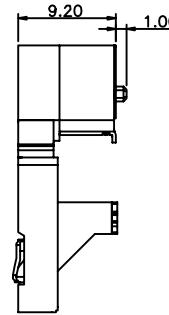
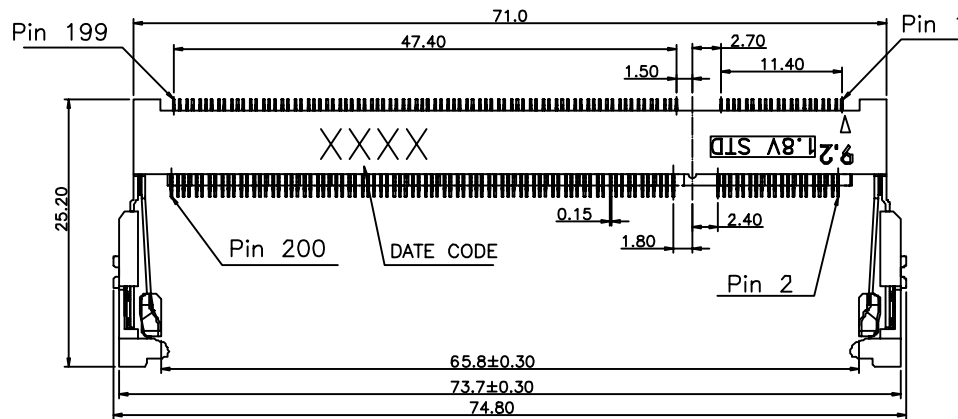

[J4318-2001103LFR92] SERIES
 SO DIMM Socket
 1.8V DDR RAM
 Height 9.2mm,Standard.
 Physical:
 Housing: LCP,UL94V-0
 Contact: Copper Alloy
 Specifications:
 Current Rating: 1.0A. 30V AC
 Insulation Resistance: 1000M ohm min
 Contact Resistance: 30m ohm max
 Dielectric Withstanding Voltage:
 AC 500V For 1 Minute
 Temperature Rating: -55°C To +105°C
 Wave soldering Temperature:
 Lead Part: 220±5°C,5 Sec
 RoHS Part: 260±5°C,5 Sec

ORDERING CODE:

J4318-200 11 0 3 LF R92
 1 2 3 4 5 6 7

- SERIES NO.
- NO. OF PINS
200=200PINS
- PLATED
01=SELECTIVE GOLD FLASH
11=FULL GOLD FLASH
15=FULL GOLD PLATED 10u"
- COLOR
0=BLACK
- ECN CODE
- PRODUCT'S STATUS
LF=RoHS COMPLIANT
- PACKAGE
NON-SHOWED=TRAY
R=REEL

DO NOT SCALE DRAWING

DIMENSIONS:
 MM [INCH] INCH [MM] MM ONLY

UNLESS OTHERWISE SPECIFIED,
 GENERAL TOLERANCE:

DECIMALS	ANGLES
X. ±0.38 [0.015]	X° ±3°
.X ±0.25 [0.010]	.X° ±1.0°
.XX ±0.20 [0.008]	

CAD GENERATED DRAWING,
 DO NOT MANUALLY UPDATE

THIRD ANGLE PROJECTION

JJP Jen Jia Precision Technology Co., Ltd.			
TITLE	SO DIMM,DDR II,200P,H9.2,REV,1.8V		
PART NO.	J84139-2001103LFR92	APPROVED BY	JASON MENG
DRAWING NO.	J84139-2001103LFR92	CHECKED BY	STEVEN LIU
MATERIAL		DRAWN BY	Darren Xia
FINISH		GENERATD DATE	2008-03-08
SCALE	SHEET	REV.	SIZE: A4
FREE	1/4	1	FILE NO.:JJP-A-05-003

THE INFORMATION CONTAINED IN THIS DOCUMENT IS PROPRIETARY TO JEN JIA PRECISION TECHNOLOGY CO.,LTD. ANY REPRODUCTION IN PART OR WHOLE WITHOUT PRIOR WRITTEN APPROVAL OR AUTHORIZATION OF JEN JIA PRECISION TECHNOLOGY CO.,LTD IS STRICTLY PROHIBITED.

RoHS COMPLIANT

REVISIONS

REV	ECN NO.	DESCRIPTION	APPROVED BY	DATE
1		PROPOSAL DRAWING	JASON MENG	2008-03-08

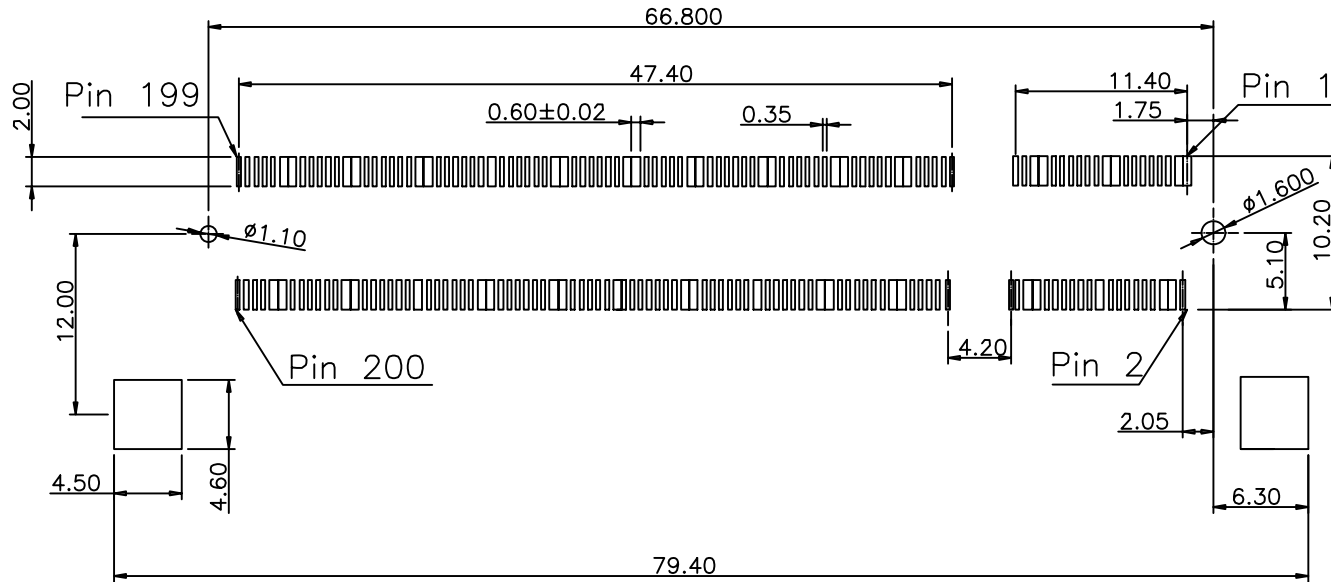

TOP VIEW
PCB LAYOUT RECOMMENDED

DO NOT SCALE DRAWING

DIMENSIONS:
 MM [INCH] INCH [MM] MM ONLY
 UNLESS OTHERWISE SPECIFIED,
 GENERAL TOLERANCE:
 DECIMALS ANGLES
 X. ±0.38 [0.015] X° ±3°
 .X ±0.25 [0.010] .X° ±1.0°
 .XX ±0.20 [0.008]

CAD GENERATED DRAWING,
DO NOT MANUALLY UPDATE
 THIRD ANGLE PROJECTION

JJP Jen Jia Precision Technology Co., Ltd.

TITLE	SO DIMM,DDR II,200P,H9.2,REV,1.8V		
PART NO.	J84139-2001103LFR92	APPROVED BY	JASON MENG
DRAWING NO.	J84139-2001103LFR92	CHECKED BY	STEVEN LIU
MATERIAL		DRAWN BY	Darren Xia
FINISH		GENERATD DATE	2008-03-08
SCALE	SHEET	REV.	SIZE: A4
FREE	2/4	1	FILE NO.:JJP-A-05-003

THE INFORMATION CONTAINED IN THIS DOCUMENT IS PROPRIETARY TO JEN JIA PRECISION TECHNOLOGY CO.LTD. ANY REPRODUCTION IN PART OR WHOLE WITHOUT PRIOR WRITTEN APPROVAL OR AUTHORIZATION OF JEN JIA PRECISION TECHNOLOGY CO.LTD IS STRICTLY PROHIBITED.

RoHS COMPLIANT

REVISIONS

REV	ECN NO.	DESCRIPTION	APPROVED BY	DATE
1		PROPOSAL DRAWING	JASON MENG	2008-03-08

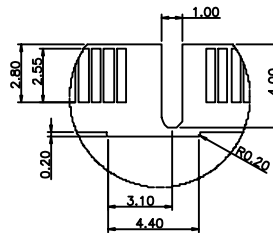
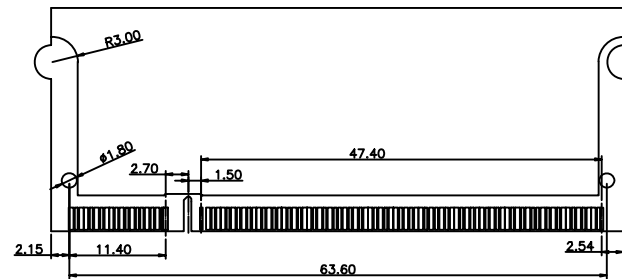
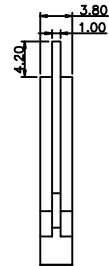
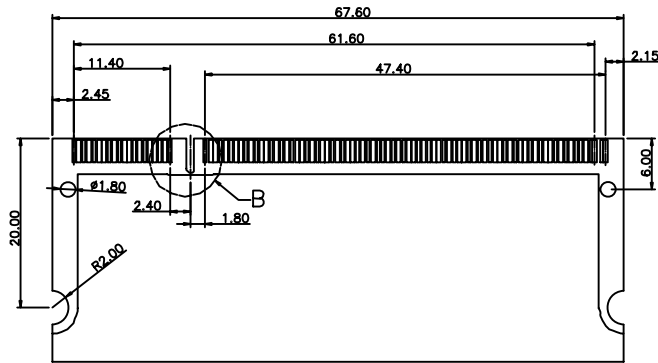

(B: 4:1)

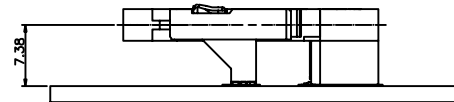
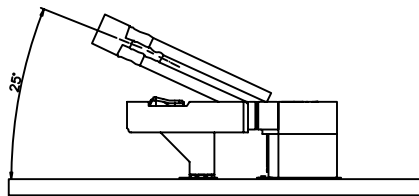

DO NOT SCALE DRAWING

DIMENSIONS:
 MM [INCH] INCH [MM] MM ONLY

UNLESS OTHERWISE SPECIFIED,
 GENERAL TOLERANCE:

DECIMALS ANGLES
 X. ±0.38 [0.015] X° ±3°
 .X ±0.25 [0.010] .X° ±1.0°
 .XX ±0.20 [0.008]

CAD GENERATED DRAWING,
 DO NOT MANUALLY UPDATE

THIRD ANGLE PROJECTION



JJP Jen Jia Precision Technology Co., Ltd.

TITLE	SO DIMM,DDR II,200P,H9.2,REV,1.8V		
PART NO.	J84139-2001103LFR92	APPROVED BY	JASON MENG
DRAWING NO.	J84139-2001103LFR92	CHECKED BY	STEVEN LIU
MATERIAL		DRAWN BY	Darren Xia
FINISH		GENERATD DATE	2008-03-08
SCALE	SHEET	REV.	SIZE: A4
FREE	3/4	1	FILE NO.:JJP-A-05-003

THE INFORMATION CONTAINED IN THIS DOCUMENT IS PROPRIETARY TO JEN JIA PRECISION TECHNOLOGY CO.,LTD. ANY REPRODUCTION IN PART OR WHOLE WITHOUT PRIOR WRITTEN APPROVAL OR AUTHORIZATION OF JEN JIA PRECISION TECHNOLOGY CO.,LTD IS STRICTLY PROHIBITED.

RoHS COMPLIANT

REVISIONS

REV	ECN NO.	DESCRIPTION	APPROVED BY	DATE
1		PROPOSAL DRAWING	JASON MENG	2008-03-08

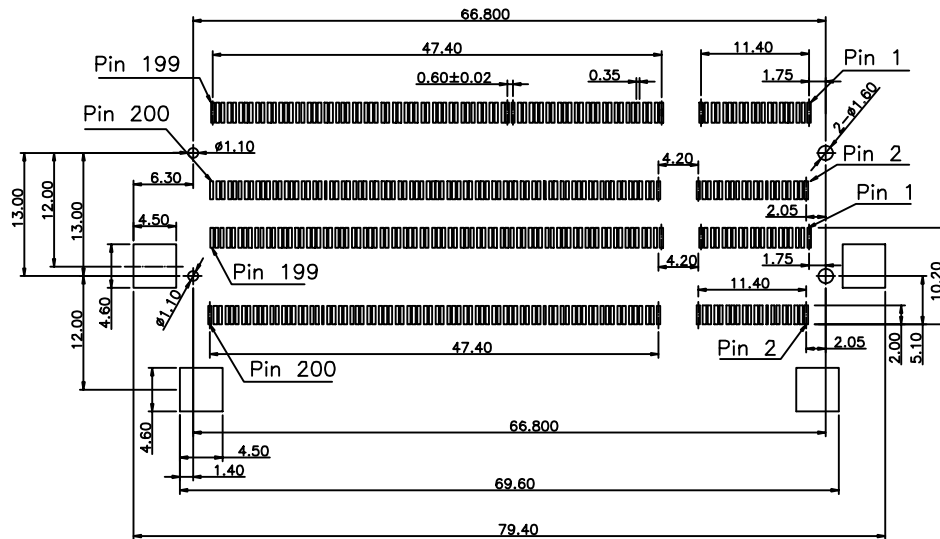
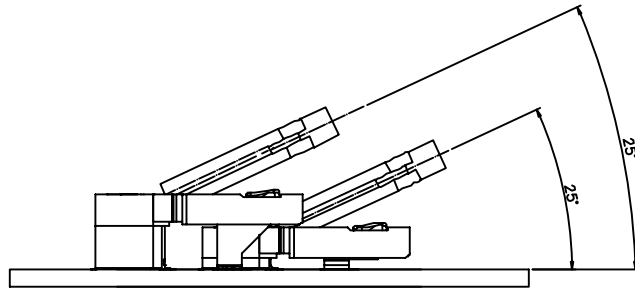
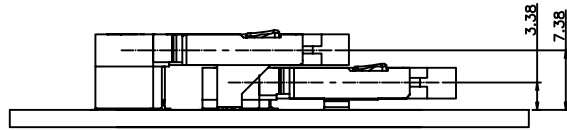

DO NOT SCALE DRAWING

DIMENSIONS:
 MM [INCH] INCH [MM] MM ONLY
 UNLESS OTHERWISE SPECIFIED,
 GENERAL TOLERANCE:
 DECIMALS ANGLES
 X. ±0.38 [0.015] X° ±3°
 .X ±0.25 [0.010] .X° ±1.0°
 .XX ±0.20 [0.008]

CAD GENERATED DRAWING,
 DO NOT MANUALLY UPDATE
 THIRD ANGLE PROJECTION

JJP Jen Jia Precision Technology Co., Ltd.

TITLE	SO DIMM,DDR II,200P,H9.2,REV,1.8V		
PART NO.	J84139-2001103LFR92	APPROVED BY	JASON MENG
DRAWING NO.	J84139-2001103LFR92	CHECKED BY	STEVEN LIU
MATERIAL		DRAWN BY	Darren Xia
FINISH		GENERATD DATE	2008-03-08
SCALE	SHEET	REV.	SIZE: A4
FREE	4/4	1	FILE NO.:JJP-A-05-003